



## Polaview 110 Projector

### User Guide



**FCC Statement**

Warning: This equipment generates, uses and can radiate radio frequency energy and, if not installed and used in accordance with the instruction manual, may cause interference to radio communications. It has been tested and found to comply with limits for a Class "A" computing device pursuant to Subpart B of Part 15 of the FCC Rules, which are designed to provide reasonable protection against such interference when operated in a commercial environment. Operation of this equipment in a residential area is likely to cause interference in which case the user, at his own expense, will be required to take whatever measures may be necessary to correct the interference.

Warning: Changes or modifications to this unit not expressly approved by Polaroid could void the user's authority to operate the equipment.

**Canadian Notice**

This digital apparatus does not exceed the Class A limits for radio noise emissions from digital apparatus set out in the Radio Interference Regulations of the Canadian Department of Communications.

Le présent appareil numérique n'émet pas de bruits radioélectriques dépassant les limites applicables aux appareils numériques de la classe A prescrites dans le Règlement sur le brouillage radioélectrique édicté par le ministère des Communications du Canada.

**European Notice**

Warning: This is a Class A product. In a domestic environment this product may cause radio interference in which case the user may be required to take adequate measures. The "CE" mark certifies that this product satisfies the requirements of the EU (European Union) regarding safety, public health, environment and consumer protection. ("CE" is the abbreviation of Conformité Européenne.) This product is in conformity with the following directives: 73/23/EEC, low voltage directive; 89/33/EEC, EMC directive; 93/68/EEC, "CE" marking directive.

© Copyright 1996 Polaroid Corporation. All rights reserved. Specifications are subject to change without notice.

# Table of contents

---

## **1 Introduction**

What's in the box?	2
Quick start	3
Connector panel	6
Control panel	7

---

## **2 Detailed setup**

Your Polaview Model 110 Projector	9
Getting started	10
Connector panel	13
Supplying power to the projector	15
Computer video and audio connections	16

---

## **3 Using the projector**

Turning on the projector and lamp	25
Control-panel keys	28
Using the remote control	31
Using the Main menu	36

---

**3 Using the projector**

---

SETUP menu	37
INPUT menu	39
IMAGE menu	40
OPTION (OPT.) menu	42
Setting the timer	44
Quick menus	44

---

**4 Maintenance**

---

Cleaning the lens	45
Replacing the lamp	46
Cleaning the air filter	48
Changing the remote-control batteries	50

---

**5 Troubleshooting**

---

Troubleshooting guide	51
Where to get help	55
Polaroid Offices and Service Centers	56
One Year Warranty	58

<b>Appendix A:</b> Specifications	59
-----------------------------------	----

---

<b>Appendix B:</b> Parts	61
--------------------------	----

---

<b>Index</b>	63
--------------	----

---

# 1 Introduction

The Polaroid Polaview Projector family consists of portable, color data and video projection products that make sharing data and presenting information as easy as connecting your computer to your monitor.

This manual covers the Polaview Model 110 Projector, which provides images of unrivaled clarity and color accuracy.

***The Polaview  
Model 110 Projector  
in use***

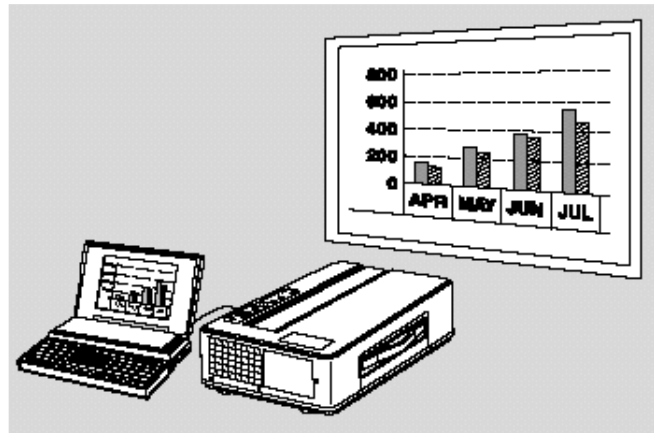

## ***What's in the box?***

---

After you open the box and take out the projector and accessory packs, make sure you have all of the items shown.

Caution! The projector should be treated like any other precision optical instrument. Handle it carefully.

### ***Items included with the projector***

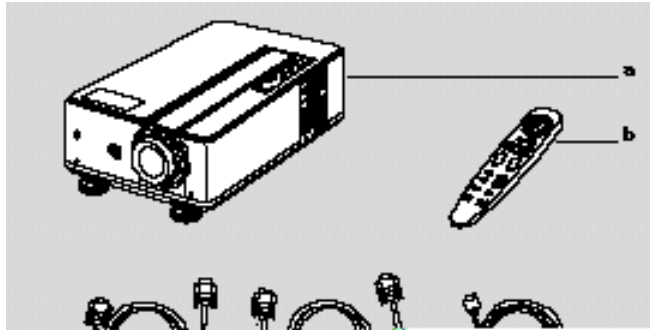

- |                             |                                    |
|-----------------------------|------------------------------------|
| a Projector                 | f AV cable                         |
| b Remote control            | g Mini-stereo to mini-stereo cable |
| c North American power cord | h Mac-VGA cable adapter            |
| d Serial cable              |                                    |
| e VGA video cable           |                                    |

**Also included but not shown**

- 2 AA alkaline batteries
- European power cord
- User's guide
- U.K. power cord
- Product registration card

**Quick start**

---

Place the Model 110 projector on a solid flat surface at a right angle (perpendicular) to the projection screen, parallel to the floor. Follow the appropriate section below for the type of system that you have. These steps are described in Chapter 2, *Detailed setup*.

Note: The projector has two sets of computer video and audio inputs. The following examples describe the use of input 1.

Desktop PCs

- 1 Unplug the monitor cable from the computer.
- 2 Plug one end of the supplied VGA cable into the RGB 1 IN port on the projector. Plug the other end into the computer Monitor Out port.
- 3 Connect your audio source to the AUDIO 1 IN port on the projector.
- 4 You can project without using the PC monitor. To use the monitor, plug the monitor cable into the RGB OUT port on the projector.
- 5 Turn the projector on and press the STANDBY/ON key.

Desktop Macintosh computers

- 1 Unplug the monitor cable from the computer.
- 2 Plug one end of the supplied VGA video cable into the RGB IN 1 port on the projector. Attach the VGA end of the Mac - VGA cable adapter to the other end of the VGA video cable.

- 3 Plug the Mac end of the Mac - VGA cable adapter into your computer Video port.
- 4 Connect your audio source to the AUDIO 1 IN port on the projector.
- 5 To project and view the monitor at the same time, plug the monitor cable into the RGB OUT port of the projector.

Note: The projector only supports the Multi-Sync standard for separate monitors to be used with Macintosh desktop computers. Other monitor connectors cannot be used.

- 6 Turn the projector on and press the STANDBY/ON key.

Note: If you turn the projector off while the computer is running, the external monitor goes blank. This is normal. Just turn the projector on again and the monitor display returns.

### Notebooks

Note: If you are connecting the projector to an Apple PowerBook, attach the Mac - VGA cable adapter to the computer Video Out port (or video adapter cable).

- 1 Plug the COMPUTER end of the VGA video cable into the notebook VGA Out port or into the Mac - VGA cable adapter (Macintosh only).
- 2 Plug one end of the VGA video cable into the RGB 1 IN port on the projector.
- 3 Connect your audio source to the AUDIO 1 IN port on the projector.
- 4 Turn on the projector and press the STANDBY/ON key.



#### Special configurations

If your computer has an internal monitor but no external video capability (such as the Macintosh Performa 575, PowerMac 5200, and certain PowerBooks), you need a video adapter card to attach it to the Model 110 projector.

Setup for a third-party adapter is identical to the procedures outlined in the *Quick start* section above. Contact your dealer, Polaroid Customer Service, or a third-party supplier for more information about an appropriate video adapter.

## Connector panel

All connections between the Model 110 projector and computer or video source are made on the side connector panel.

### The connector panel

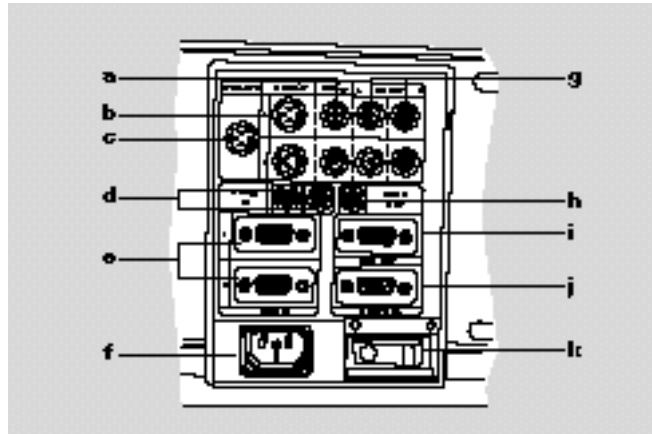

<b>Connector</b>	<b>Description</b>
a VIDEO 1 & 2	Connects to video output from an NTSC, PAL, or SECAM source.
b S-VIDEO 1 & 2	Connects to an S-Video source.
c CYCLOPS port	Connects your computer to the Cyclops interactive pointer system.
d AUDIO IN 1 & 2	Connects to stereo/mono audio output from a computer.
e RGB IN 1 & 2	Connects computer video to the projector.
f Power receptacle	For AC power-cord connection.
g L-AUDIO-R 1 & 2	Connects to stereo/mono audio output from an NTSC, PAL, or SECAM source.

	<b>Connector</b>	<b>Description</b>
h	AUDIO OUT	Provides audio output to an external stereo system.
i	RGB OUT	Provides computer output to a separate monitor.
j	CONTROL	Connects to a serial cable for computer control.
k	Power switch	Turns power on and off.

## **Control panel**

The projector control-panel keys are used to turn the projector on or off, adjust the projected image, and to display and hide the menu. Power, warning, and alert lights give you important information about how your projector is working.

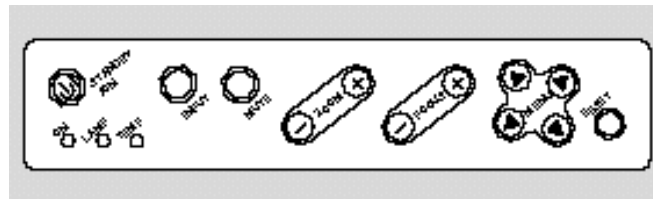

<b>Key</b>	<b>Function</b>
STANDBY/ON	Turns the lamp on or off.
INPUT	Switches the video inputs.
MUTE	Turns the audio on or off.
ZOOM +/-	Zooms in and out.
FOCUS +/-	Adjusts the focus.

<b>Key</b>	<b>Function</b>
MENU	Controls the menu.
RESET	Resets the image to the factory defaults.
ON	Flashes green during start-up. Glow green if AC input and projector power supplies are functioning. Glow red if they are not, or if the air filter door is removed.
TEMP	Glow red to warn of an over-temperature condition. Flashes red if the fan is not working.
LAMP	Glow red if the projection lamp burns out.

### ***Options and accessories***

Cyclops interactive pointer system

The Proxima Cyclops interactive pointer system uses a built-in camera to function like a cordless mouse. With the Cyclops system, you can control your computer cursor on then projected image by moving the hand-held wand or optional hand-held laser pointer.

# 2 Detailed setup

## ***Your Polaview Model 110 Projector***

---

Before you begin, examine the components of the projector.

### ***The Polaroid Polaview Model 110 Projector and the Cyclops Remote Control***

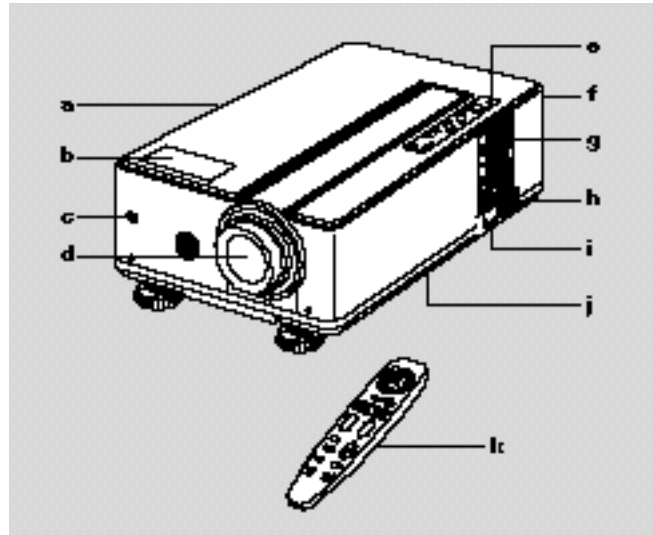

- |   |                          |   |                       |
|---|--------------------------|---|-----------------------|
| a | Handle                   | g | Connector panel       |
| b | Internal speaker         | h | AC power switch       |
| c | Infrared lens            | i | Power-cord receptacle |
| d | Projection lens assembly | j | Bottom intake filter  |
| e | Control panel            | k | Remote control        |
| f | Rear exhaust             |   |                       |

## Getting started

---

Place the projector on a solid, flat surface at a right angle (perpendicular) to the projection screen and parallel to the floor. If you use a media cart, make sure the wheels are locked to prevent it from moving.

### Positioning the projector

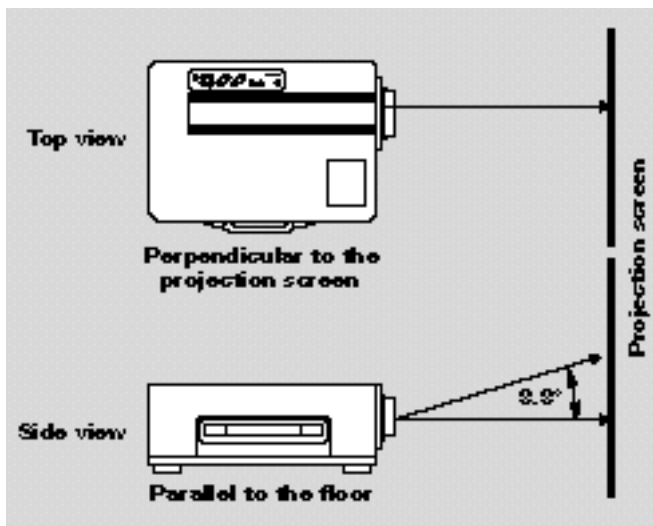

***Transporting and moving the projector***

The projector has a recessed handle located in one of the side panels. Always use the handle to transport the projector. The projector has protective feet on the side opposite the handle, as well as on the bottom.

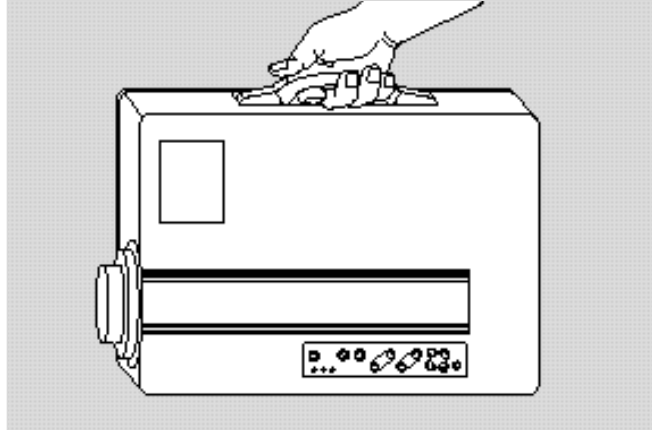
***Transporting the projector***

If you are moving the projector a short distance, grasp the sides of the projector securely, as shown below, to stabilize the weight of the unit.

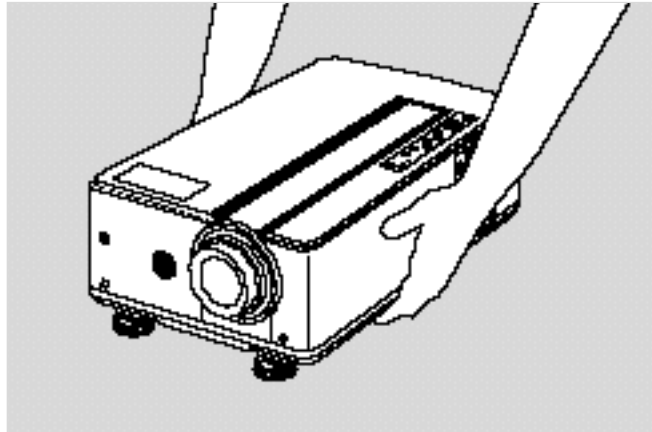
***Moving the projector***

**Projector cooling  
and airflow**

The air intake grill is on the bottom of the projector. The air exhaust grill is on the rear panel.

Caution! Never operate the projector if these grills are clogged or obstructed, or if the electric fans are not running.

**Allow for proper  
airflow**

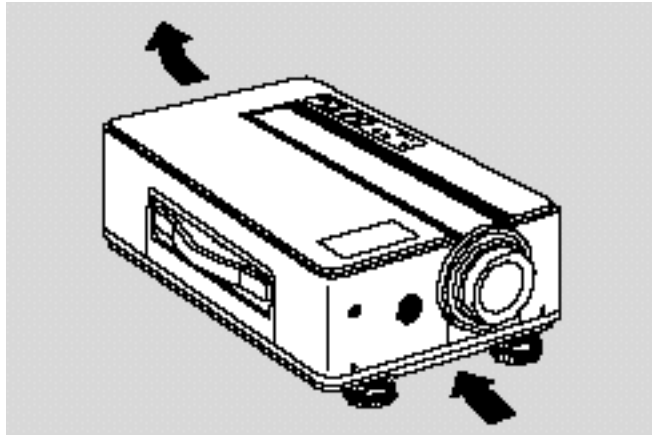



## Connector panel

All connections between the projector and your computer or video source are made on the side connector panel.

### The connector panel

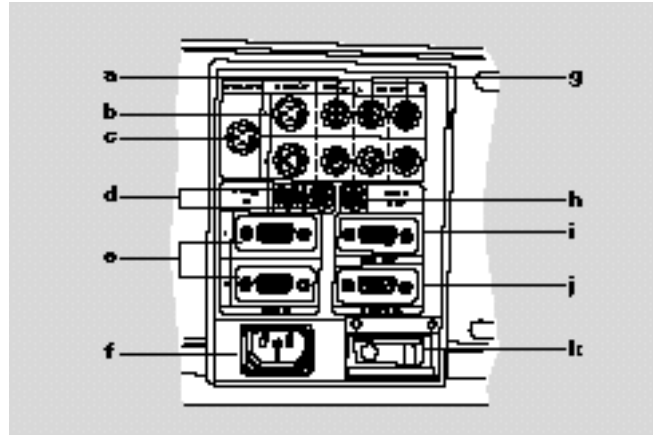

<b>Connector</b>	<b>Description</b>
a VIDEO 1 & 2	Connects to video output from an NTSC, PAL, or SECAM source.
b S-VIDEO 1 & 2	Connects to an S-Video source.
c CYCLOPS port	Connects your computer to the Cyclops interactive pointer system.
d AUDIO IN 1 & 2	Connects to stereo/mono audio output from the computer.
e RGB IN 1 & 2	Connects computer video to the projector.
f Power receptacle	For AC power-cord connection.

	<b>Connector</b>	<b>Description</b>
g	L-AUDIO-R 1 & 2	Connects to stereo/mono audio output from an NTSC, PAL, or SECAM source.
h	AUDIO OUT	Provides audio output to an external stereo system.
i	RGB OUT	Provides computer output to a separate monitor.
j	CONTROL	Connects to a serial cable for computer control.
k	Power switch	Turns power on and off.

## Supplying power to the projector

---

The power-cord receptacle and AC power switch are located below the projector connector panel.

### **Power receptacle and AC power switch**

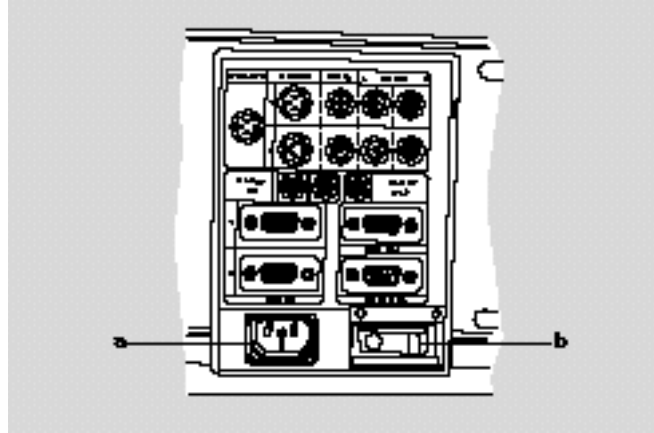

- a Power receptacle
- b AC power switch

To supply power to the projector:

- 1 Plug the appropriate power cord into the power receptacle on the side of the projector.
- 2 Connect the power cord to a properly-grounded wall outlet.

## Computer video and audio connections

### Connecting a PC

Use the included VGA video cable to connect your PC to the projector. If you want to use your monitor and projector at the same time, use your existing monitor cable to connect the projector to a separate monitor.

### VGA video cable

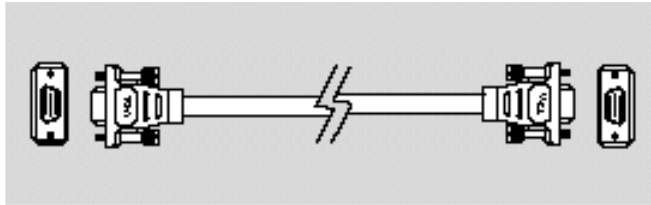

### VGA connections

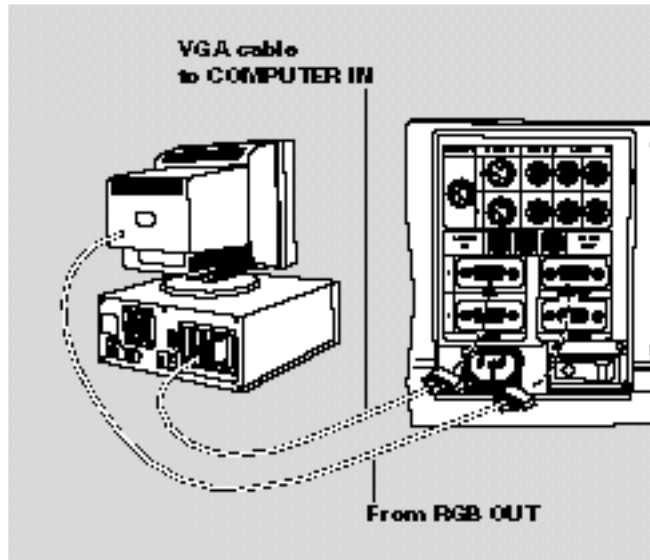

- 1 Unplug the monitor cable from the computer.
- 2 Plug one end of the supplied VGA cable into the RGB IN 1 port on the projector. Plug the other end of the VGA cable into the computer Video Out (VGA) port.

- 3 Connect your audio source to the AUDIO IN 1 port on the projector. Refer to *Connecting computer audio* later in this chapter.

Note: If you are using a second computer video or audio source, plug the output cables for these sources into the RGB IN 2 and AUDIO IN 2 connectors.

- 4 If you want to use an external monitor, connect the monitor cable to the RGB OUT port of the projector.
- 5 Turn the projector on and press the STANDBY/ON key.

Note: To use the projector, you do not need an external monitor.

### **Connecting Macintosh computers**

#### **The Macintosh cable adapter**

Use the video cable adapter shown below to connect a Macintosh computer to the projector.

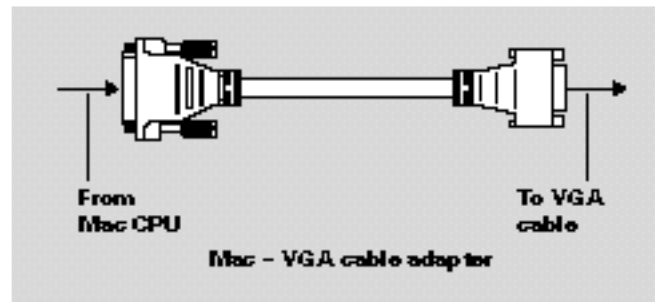

Use the cable adapter and supplied VGA video cable to connect the projector to your Macintosh computer.

### Macintosh connections

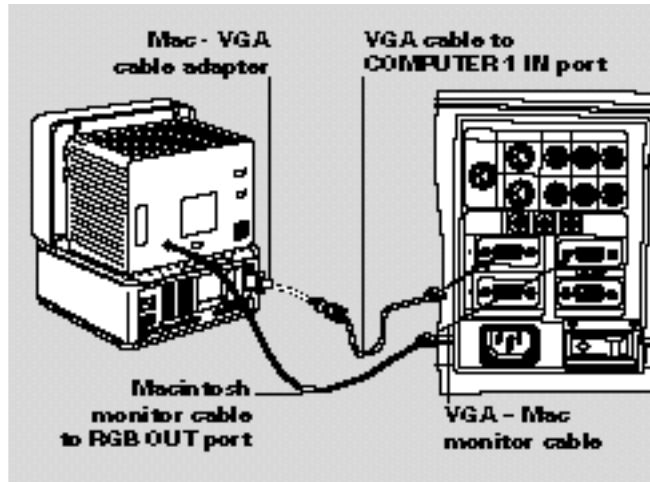

- 1 Unplug the Macintosh monitor cable from the computer.
- 2 Plug one end of the supplied VGA video cable into the RGB IN 1 port on the projector. Attach the VGA end of the Mac - VGA cable adapter to the other end of the VGA video cable.
- 3 Plug the Mac end of the Mac - VGA cable adapter into the Macintosh video port.
- 4 Connect the audio source to the projector AUDIO IN 1 port. Refer to *Connecting computer audio* later in this chapter.

Note: If you are using a second computer video or audio source, plug the output cables for these sources into the RGB IN 2 and AUDIO IN 2 connectors.

Use your existing monitor cable to connect the projector to a separate computer monitor, so you can use the projector and monitor at the same time.

Note: The projector only supports the Multi-Sync monitors for Macintosh computers. Other monitors cannot be used.

- 5 Turn the projector on and press the STANDBY/ON key.

## Connecting notebook computers

### Laptop connections

Note: To use the projector, you do not need an external monitor.

Use the appropriate cable and adapter to connect your portable computer to the projector.

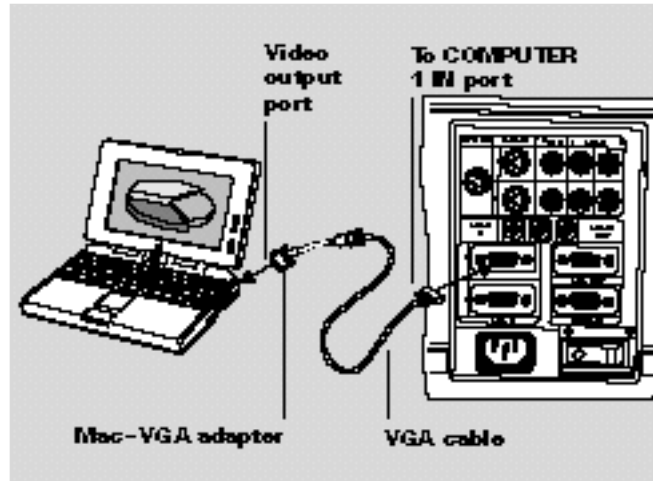

Note: If you are connecting the projector to an Apple PowerBook, attach the Mac - VGA cable adapter to the computer VIDEO OUTPUT port (or video adapter cable).

- 1 Plug the COMPUTER end of the VGA cable into the computer VGA or Video Out port or into the Mac - VGA cable adapter (Macintosh only).
- 2 Plug one end of the supplied VGA cable into the RGB IN 1 port on the projector.
- 3 Connect your audio source to the AUDIO IN 1 port on the projector.
- 4 Turn the projector on and press the STANDBY/ON key.

Note: If your projector does not project an image at the same time your laptop monitor displays an image, refer to your laptop documentation for information on switching between the internal screen and the video port.

### Special configurations

If your computer has an internal monitor but no external video capability (Macintosh Performa 575, PowerMac 5200, and certain PowerBooks), you need a separate video-adaptor card to attach the projector to it.

Setup for a third-party adapter is identical to the procedures outlined in the *Quick start* section in Chapter 1. Contact your dealer, Polaroid Customer Service, or a third-party supplier for more information about an appropriate video adapter.

### Connecting computer audio

The AUDIO IN 1 and 2 ports allow audio input from two separate computers or microphones.

- 1 Insert the mini-jack at one end of a computer-audio cable into the AUDIO OUT port of a Macintosh or the sound card of a PC.
- 2 Insert the mini-jack at the other end of the AV cable into the projector AUDIO 1 or 2 ports.

Note: Although two COMPUTER AUDIO sources and two other AUDIO sources may be connected simultaneously, only one can be active. If computer video is selected, COMPUTER AUDIO is active. If NTSC/PAL/SECAM/S-VHS video is being viewed, the L-AUDIO-R are active.

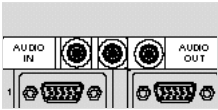



### Connecting composite video

You can display composite video (NTSC, PAL or SECAM) on the projector.

Use the supplied AV cable to connect an NTSC, PAL, or SECAM source to your projector.

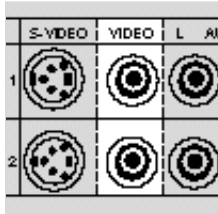

- 1 Find the RCA connector on your video source marked VIDEO OUT or something similar. This connector is usually yellow. Insert one of the yellow AV-cable connectors into the VIDEO OUT jack of the video source.
- 2 Insert the other yellow connector into the projector VIDEO 1 port.

### Connecting an S-Video source

To connect an S-Video source, use the supplied S-Video cable instead of an RCA cable connection. The S-Video cable has identical, round, 4-pin mini-DIN connectors on both ends.

To connect an S-Video source:

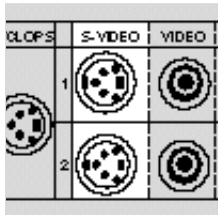

- 1 Insert one end of the S-Video cable into the mini-DIN VIDEO OUT port of the video source.
- 2 Insert the other end of the S-Video cable into the projector S-VIDEO port.
- 3 Use the red and white AV-cable connectors to connect audio from the S-Video source to the projector. See the following section, *Connecting non-computer audio*.

### Connecting non-computer audio

The AUDIO ports allow you to connect stereo or monaural audio from a composite video source to the projector.

For stereo audio, use the supplied AV cable.

- 1 Insert the red (right) and white (left) ends of the cable into the AUDIO OUT ports of a composite video audio source.
- 2 Connect the other end of each cable to the projector AUDIO IN ports.

Note: Although two COMPUTER AUDIO sources and two other AUDIO sources may be connected simultaneously, only one can be active. If computer video is selected, COMPUTER AUDIO is active. If NTSC/PAL/SECAM/S-VHS video is being viewed, AUDIO is active.

If your audio source is monaural, connect it to the left AUDIO port.

### Connecting the PC to the projector through the CONTROL port

You can connect the projector to a computer through the CONTROL port. You can then use the joystick on your remote control as the computer system mouse (see *Using the joystick* in Chapter 3). Before you begin, make sure the projector and computer power are on and that the cables are securely connected.

Note: This CONTROL feature is only available for PCs.

### Connecting the Cyclops interactive pointer system

Use the CYCLOPS port to connect the projector and optional Cyclops interactive pointer system to the computer. You can use the Cyclops system to control your computer on-screen mouse cursor.

The optional Cyclops interactive pointer system is shipped with its own installation and user's guides. The Cyclops kit also includes extra cables to connect the projector and the computer.

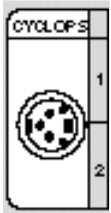

- 1 Connect one end of the appropriate serial cable to the CYCLOPS port of the projector.
- 2 Connect the other end of the cable to the computer:
  - On a PC, connect the computer end to a serial port.
  - On a Macintosh, connect the computer end to an ADB connector.

### Projector AUDIO OUT

The projector contains an internal stereo system consisting of an amplifier and one speaker. Although this system provides high-quality audio output, a multimedia presentation may require independently powered stereo speakers or an external sound system.

Note: Use the MUTE key to turn on or off the internal or any external speakers connected to the projector.



To connect your projector to an external stereo system:

- 1 Insert one end of a computer audio cable into the AUDIO OUT port of the projector.
- 2 Insert the plug at the other end into the external amplifier or AUDIO IN port of the speaker system.

# 3 Using the projector

## ***Turning on the projector and lamp***

---

Turn on the projector before you turn on your computer. This allows the computer to sense the projector during its startup sequence.

Move the AC power switch to the ON position. The ON indicator on the projector control panel glows orange.

The lamp is off when you first turn on the projector. Press the STANDBY/ON key on the operator panel for one second to turn the lamp on. The ON indicator blinks for a few seconds while the lamp warms up, and then turns a steady green. Next, turn on your computer.

**Caution!** Never operate the projector if the air intake or exhaust grills are clogged or obstructed, or if the electric fans are not running.

**Projector  
STANDBY/ON key**

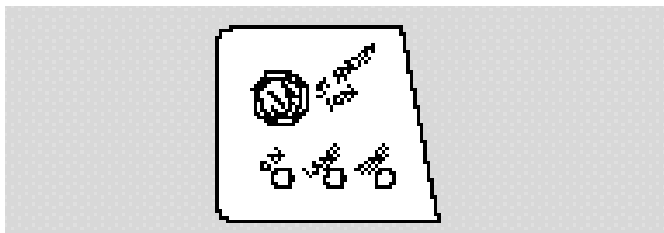

**Focusing and zooming  
the image**

You can use the title screen image that appears when you first start the projector to make your focus and image-size adjustments.

- 1 Press the ZOOM +/- key on the control panel or remote control to make the image larger (+) or smaller (-).

Note: If you have a Cyclops interactive pointer system installed and you change the image size, you must recalibrate the Cyclops camera.

- 2 Adjust the focus using the FOCUS +/- buttons on the control panel or remote control.

**Image size**

The size of the projected image changes as you move the projector closer to the screen or adjust the zoom lens. The following table indicates the minimum and maximum distance from the projector to the screen for most standard size screens.

<b>Screen size</b>	<b>Distance from projector screen</b>	
	<b>Minimum</b>	<b>Maximum</b>
40 in.	53.9 in.	87.8 in.
60 in.	82.3 in.	134 in.
80 in.	111 in.	179 in.
100 in.	139 in.	224 in.
120 in.	168 in.	270 in.
150 in.	210 in.	338 in.
200 in.	281 in.	452 in.

**Turning off the projector**

- 1 Press and hold the STANDBY/ON key on the control panel for one second to turn the lamp off. When using the remote control, press and hold the STANDBY/ON key for two seconds.
- 2 The fan stops about one minute later and the ON indicator starts to glow. Turn the AC power switch off.

## Control-panel keys

The control-panel keys are used to turn the projector on or off, adjust the projected image, and to display and hide the menus. Power, warning, and alert lights give you important information about how your projector is working.

### Control-panel keys

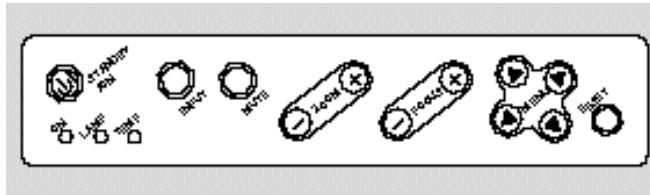

<b>Key</b>	<b>Function</b>
STANDBY/ON	Turns the lamp on or off.
INPUT	Switches between active connected video inputs.
MUTE	Turns the audio on or off.
ZOOM +/-	Zooms in and out. Press + to make the picture larger. Press - to make the picture smaller.
FOCUS +/-	Adjusts the focus of the image.
MENU	Controls the menu.
RESET	Resets all image settings to the factory defaults. Hold the button down to display the number of hours that the lamp has already been used.

**MENU**

Press the MENU keys to display the menu options above the projected image. If a menu selection is not made within five seconds, the menu disappears. Menu settings are automatically stored when you exit the menus or turn off the projector. See *The graphical user interface* later in this chapter for more information.

**Control-panel indicators**

Power, warning, and alert indicators give you important information about how your projector is working.

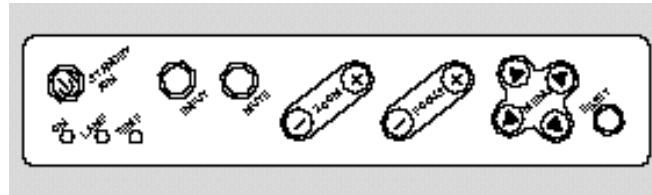

<b>Indicator</b>	<b>Function</b>
ON	<p>Glows green if AC input and projector power supplies are functioning properly. Glows red if not, or if the air-filter door is removed.</p> <p>Glows orange while in standby mode.</p> <p>Flashes green during lamp start-up.</p> <p>Flashes orange during lamp cool-down.</p>
TEMP	<p>Glows red to warn of an over-temperature condition or if the air-filter door on the bottom of the projector is open.</p>
LAMP	<p>Glows red if the projection lamp burns out. Flashes red if the air-filter door is removed.</p>



**TEMP indicator**

The TEMP indicator illuminates if the projector overheats or if the air-filter door on the bottom of the projector is open. A thermostat automatically turns off the power to the lamp until the projector cools.

If an over-temperature condition occurs, perform the following checks while you allow the projector to cool:

- Make sure the room temperature is below 95°F (35°C).
- Check the intake and exhaust vents. Clear any obstruction to the airflow.
- Make sure the fans are working. If the projector has reached an over-temperature condition and the fans are working, you should feel a strong flow of hot air from the top vent and a strong rush of air directly into the front and rear of the projector. If either fan is not working, the projector needs service.

After the projector returns to its normal operating temperature, you must turn the main power switch off and back on to clear the over-temperature indicator. Press the STAND-BY/ON key on the control panel to relight the lamp.

Note: The remote control STANDBY/ON button does not function after an over-temperature condition until the main power switch is turned off and on and the lamp is turned on from the control panel.

**LAMP indicator**

The LAMP indicator flashes red if the air-filter door is removed. The lamp indicator glows a steady red if the lamp burns out.

Caution! If the lamp fails during a presentation, make sure that the projector cools for a few minutes with the projector off before you attempt to change the lamp. See Chapter 4, *Maintenance* for instructions on changing the lamps. The lamp and surrounding parts get very hot. Use appropriate care when changing the lamps.

## Using the remote control

The remote control contains all the key functions available on the projector control panel as well as several additional features. For best results, aim the remote control at the projection screen or at the front panel of the projector. Do not obstruct the infrared eye located on the front of the projector.

### The remote control and infrared eye

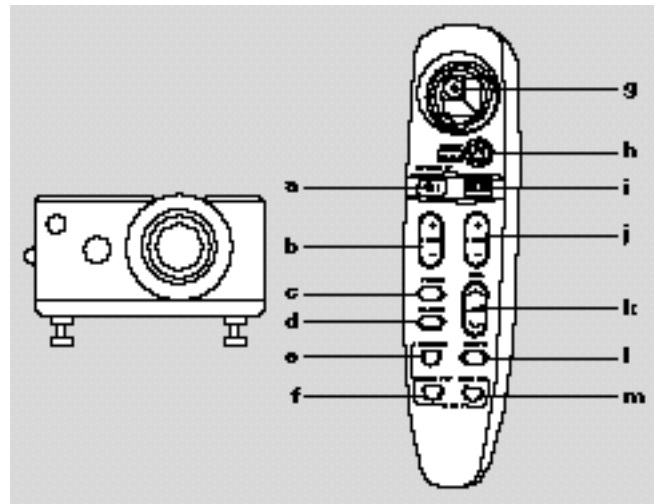

<b>Key</b>	<b>Function</b>
a STANDBY/ON	Turns the lamp on and off.
b ZOOM +/-	Zooms in and out.
c TIMER	Starts and stops the break timer.
d BLANK	Turns a solid background on and off.
e SEARCH	Switches between all connected and active video sources.
f VIDEO 1/2	Switches between connected video sources.

	<b>Key</b>	<b>Function</b>
g	JOYSTICK	Functions as arrow keys or as a mouse.
h	RIGHT/RESET	Resets the projector settings to the factory defaults if the menus are open. Functions as a right mouse button if the projector is in the Host mode. See <i>Operating the projector</i> later in this chapter.
i	MENU	Displays or hides the menu.
j	FOCUS +/-	Adjusts the focus.
k	VOLUME +/-	Decreases or increases the volume of internal and/or external speakers.
l	MUTE	Turns audio on or off.
m	RGB 1/2	Switches between connected computer sources.

**Using the joystick**

Use the joystick to move through the menus and select items or change values in them. You can also use the joystick as your system mouse if you install the serial cable and follow the boot instructions detailed in the *Host mode* section on the next page.

- Move the joystick left or right to move across the menus.
- Move the joystick up or down to move up or down in a menu. Move the joystick up to move up one level when you are at the top of a menu.
- Press the joystick to make a menu selection.

If you are operating in Host mode, the joystick provides the following functions:

- Move the joystick up, down, left or right to move the cursor.
- Press the joystick to initiate a mouse click.
- Press the joystick twice for a double mouse click.

**Operating the projector**

The control panel and remote control provide access to all projector features. Press a key to select a function or to navigate through the menus. The projector can operate in Local or Host mode.

**Local mode**

Any time you activate the projector menus, the projector is in Local mode. In Local mode, the remote control can be used to move through and select items in the projector menus.

**Host mode**

The projector can emulate a serial mouse, allowing you to control your computer from the joystick on the remote control. You do not need a special mouse driver to emulate a serial mouse with the remote control.

Use one of the following sections to set up your projector for mouse emulation. Before you begin, ensure that Windows 3.x, Windows 95, or OS/2 is configured to use a standard serial mouse.

Desktop computer users

- 1 Turn off your computer and disconnect the mouse.
- 2 Connect one end of the projector serial-data cable to the computer serial port and the other end to the CONTROL port on the projector.
- 3 Turn on the projector and light the lamp.
- 4 Turn on the computer. It should detect the projector as a serial mouse.
- 5 Use the joystick on the infrared remote control to move the mouse.

Notebook computer users

You may need to disable the notebook-computer integrated pointing device before you can use an external serial mouse. Consult the user's guide that came with your computer for instructions on connecting a serial mouse.

- 1 Turn off your computer.
- 2 Connect one end of the projector serial-data cable to the computer serial port and the other end to the CONTROL port on the projector.
- 3 Turn on the projector and light the lamp.
- 4 Turn on the computer. It should detect the projector as a serial mouse.
- 5 Use the joystick on the infrared remote control to move the mouse.

**The graphical user interface**

Your projector features a graphical user interface that makes it easy to control all of the projector functions. You can make menu selections with the control panel or the remote control.

Note: Menu selections differ depending on the type of video source you select.

Using the menus with the control panel

- 1 Press any of the menu keys to display the on-screen menus.
- 2 Press the  $\%$  and  $\star$  menu keys to select the desired menu. The items highlighted in green can then be changed.
- 3 Use the  $\blacktriangle$  and  $\blacktriangledown$  menu keys to move up or down a menu column or to change a menu value. For some items (e.g. Video Source), you may also need to use the ' and ... keys to gain access to an item.
- 4 The menus automatically disappear after five seconds. Settings are automatically saved when you exit the menus or turn off the projector.

Using the menus with the remote control

- 1 Press the MENU key to display the on-screen menus.
- 2 Move the joystick to the left or the right to select the desired menu. The highlighted menu items can be adjusted.
- 3 Move the joystick up or down to select items in a menu column or to change a value. For some items (e.g. Video Source), you may need to move the joystick left or right to select an item.
- 4 Press the center of the joystick to change a value or to select a check box option.
- 5 Move the joystick away from you to move up one level in any menu.
- 6 Press MENU again to close the menu, or wait five seconds and the menu automatically disappears. Settings are automatically saved when you exit the menus or turn off the projector.

## Using the Main menu

---

When you press MENU the Main menu appears at the top of the screen.

### Main menu screen

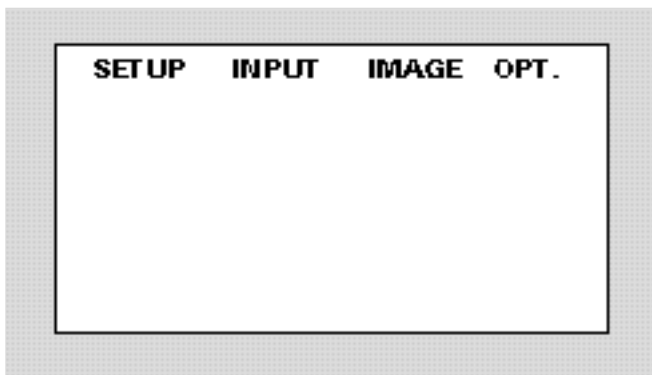

To turn the menu off, press MENU again. The menus automatically disappear after a few seconds.

The following table lists the main menu options that you can select. Note that the Input and Image menus display only those items that are relevant to the selected input source (computer, video, or S-Video).

<b>Menu</b>	<b>Function</b>
SETUP	Adjusts image quality and position.
INPUT	Selects a video input source.
IMAGE	Allows image inversion and other functions.
OPT	Changes communication functions.

### Default settings

The factory settings are indicated by            in the individual menu tables. Press RESET when any menu item is selected to return it to the factory default.

## SETUP menu

Use the SETUP menu selections to adjust image quality and position. The computer source Setup menu is shown below.

### Setup menu screen

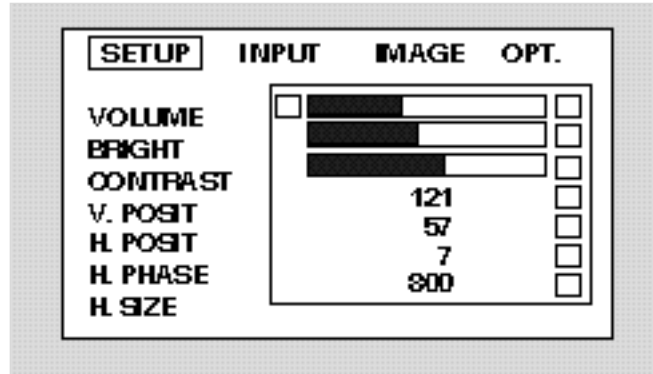

<b>Option</b>	<b>What it does</b>	<b>Source</b>
VOLUME	Increases or decreases the volume level.	All sources
BRIGHT	Increases or decreases the intensity level of the projected image.	All sources
CONTRAST	Adjusts the contrast of the projected image.	All sources
SHARPNESS*	Adjusts the sharpness of the projected image.	Video only
COLOR*	Adjusts the color saturation for NTSC, PAL, or S-VIDEO sources.	Video only
TINT*	Adjusts the red or green color balance for NTSC, or S-VIDEO sources.	Video only (except PAL)

\*Note that selections are different for each type of video source.



<b><i>Option</i></b>	<b><i>What it does</i></b>	<b><i>Source</i></b>
V. POSIT	Adjusts the vertical position of the projected image.	Computer only
H. POSIT	Adjusts the horizontal position of the projected image.	Computer only
H. PHASE	Adjusts the horizontal phase setting. Use this setting if you see uneven horizontal features, streaks, or shimmering in a computer video image.	Computer only
H. SIZE	Adjusts the width of a computer display.	Computer only

## INPUT menu

Use the Input menu to select a video source.

- Use the arrow keys to select a source.
- If you choose VIDEO 1 or VIDEO 2, select a video format.
- Select TEST PATTERN to adjust your focus.

### INPUT menu screen

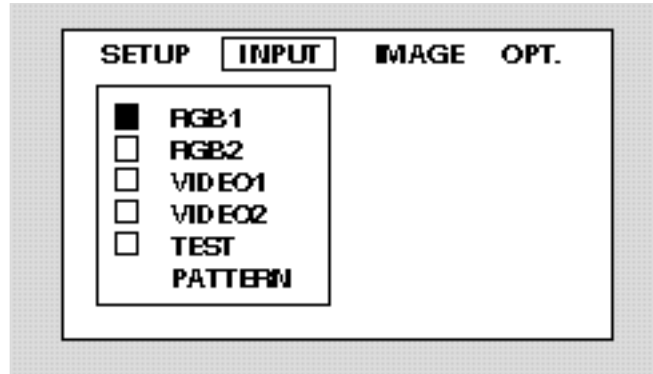

<i>Menu item</i>	<i>Options</i>	<i>Function</i>
RGB 1 or 2		Selects the RGB 1 or 2 port.
VIDEO 1 or 2		Selects the VIDEO 1 or 2 port and the video signal type: AUTO NTSC PAL SECAM
TEST PATTERN		Displays a full-screen test pattern.

## IMAGE menu

---

Use this menu to adjust the projected video image and select how the projector displays the image.

### IMAGE menu screen

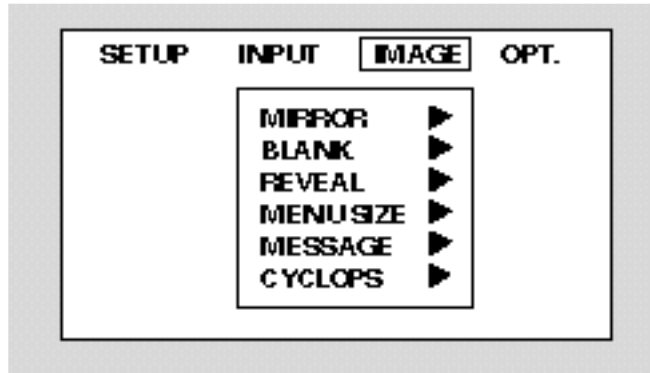

<b>Menu item</b>	<b>Options</b>	<b>Function</b>
MIRROR	<input type="checkbox"/> NORMAL <input type="checkbox"/> H: INVERT <input type="checkbox"/> V: INVERT <input type="checkbox"/> H&V: INVERT	Standard operating mode. Flips the picture horizontally, vertically, or horizontally and vertically.
BLANK	<input type="checkbox"/> WHITE <input type="checkbox"/> BLANK <input type="checkbox"/> BLACK	Selects a blank color (white, blue, or black).

<b>Menu item</b>	<b>Options</b>	<b>Function</b>
REVEAL	<input type="checkbox"/> FAST <input type="checkbox"/> ↑ <input checked="" type="checkbox"/> MEDIUM <input type="checkbox"/> ↓ <input type="checkbox"/> SLOW	Selects the speed for revealing an image.
MENU SIZE	<input type="checkbox"/> LARGE <input checked="" type="checkbox"/> SMALL	Changes the on-screen menu size.
MESSAGE	<input type="checkbox"/> TURN ON <input checked="" type="checkbox"/> TURN OFF	Turns the on-screen image source messages on or off.
CYCLOPS	<input type="checkbox"/> CALIBRATE <input checked="" type="checkbox"/> CANCEL	Initiates Cyclops calibration. See the Cyclops user's guide for more information. Press CANCEL to cancel the calibration.

## OPTION (OPT.) menu



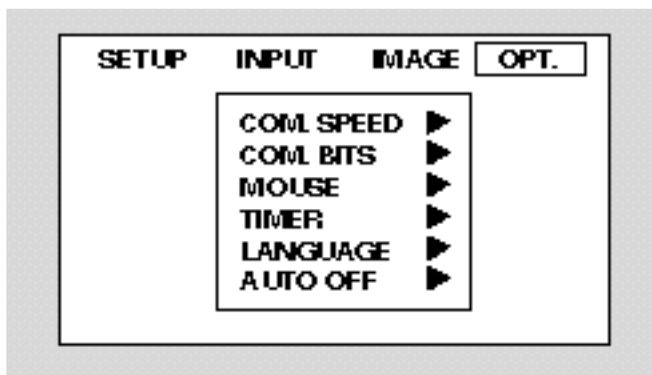

---

The OPT. menu is used to control the projector communications settings.

### OPT. menu screen

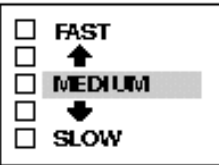

<i>Menu item</i>	<i>Options</i>	<i>Function</i>
COM. SPEED	<b>COM. SPEED bps</b> <input checked="" type="checkbox"/> 1200 <input type="checkbox"/> 2400 <input type="checkbox"/> 4800 <input type="checkbox"/> 9600 <input type="checkbox"/> 19200	Selects the speed of data transmission.
COM. BITS	<input checked="" type="checkbox"/> 7N1 <input type="checkbox"/> 8N1	Selects the format of data transmission: Use 7N1 for 7 data-bits, No parity, 1 stop bit. Use 8N1 for 8 data-bits, No parity, 1 stop bit.

<b>Menu item</b>	<b>Options</b>	<b>Function</b>
MOUSE	 A rectangular box containing five radio button options: FAST, MEDIUM (highlighted), and SLOW. Between FAST and MEDIUM is an upward arrow, and between MEDIUM and SLOW is a downward arrow.	Selects the speed of mouse movement.
TIMER	 A rectangular box containing an upward arrow, a hash symbol (#), and a downward arrow.	Sets the duration of the break timer.
LANGUAGE	 A rectangular box containing seven radio button options: ENGLISH, FRANCAIS, DEUTSCH, ESPANOL, ITALIANO, NORSK, and NEDERLANDS.	Sets the language for the menu displays.
AUTO OFF	 A rectangular box containing an upward arrow, the text ##MIN, and the text STOP.	Sets the time the projector can run with no action before it automatically turns off. The maximum is 99. Press RESET to set it to 0.

## Setting the timer

---

You can set the timer to count down for breaks, class activities, and other presentation requirements.

- 1 From the Options menu, choose Timer and press the right MENU key on the control panel or move the joystick to the right.
- 2 When the Timer menu appears, use the MENU keys on the control panel or the joystick on the remote control to set the time.
- 3 Press MENU, and the clock begins to count down.

## Quick menus

---

The projector has Quick menus for easy adjustment of volume, focus, and video source. Adjustment slide bars appear at the bottom of the screen when you press following remote-control buttons:

<b>Adjustment item</b>	<b>Function</b>
VOLUME +/-	Increases or decreases the volume level.
FOCUS +/-	Adjusts the focus of the image.
SEARCH, VIDEO 1/2, RGB 1/2	Displays the currently selected video input port.

# 4 Maintenance

Your Polaview Model 110 Projector requires minimal maintenance; however, follow these recommendations for periodic maintenance to ensure top performance.

The lamp, lenses, mirrors, and LCD panels have been carefully aligned at the factory to give you the clearest, brightest image possible. However, mishandling can cause misalignment or damage to the optical elements. Take appropriate care when you use or handle any of the optical elements.

## ***Cleaning the lens***

---

From time to time, you need to clean the lens.

- 1 Take a piece of lens tissue and form it into a loose swab. Wet it with lens cleaning fluid or denatured alcohol, and gently move it over the lens surface.
- 2 Take a part of the lens tissue that you have not touched, and repeat the process, going over the lens in another direction.

Caution: Your projector contains electric circuitry and sensitive optics. Keep fluids away from it.



## Replacing the lamp

---

- 1 Turn off the projector.
- 2 Unplug the projector power cord from the wall socket and from the projector power receptacle.
- 3 Loosen and remove the screw located on the right side of the rear panel and remove the service door.

### Removing the service door

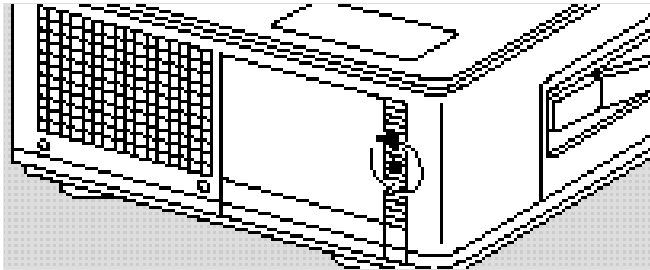

- 4 Loosen the 4 lamp-assembly screws (you cannot remove them from the service door).

### Loosening the lamp-assembly screws

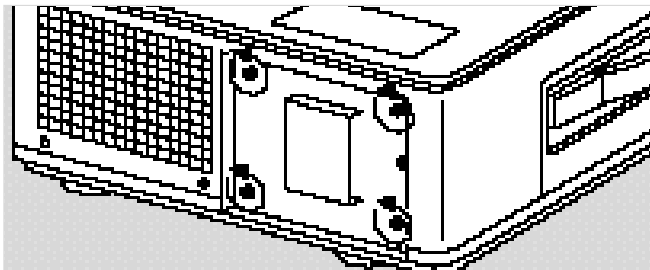

**Caution:** The lamp assembly gets very hot during operation. Use appropriate care when changing lamps. Make sure that the lamp assembly has cooled for at least 3 to 5 minutes before touching it.

- 5 Grasp the lamp assembly and firmly pull it straight out of the projector, as shown below.

***Removing the lamp assembly***

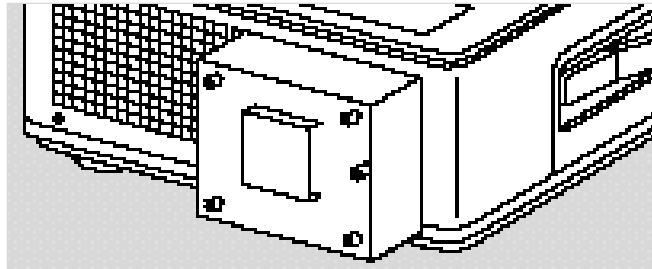

- 6 Replace the old lamp assembly with a new one, carefully aligning the power pins on the bottom, and pressing it firmly into place. When the assembly is properly installed, a small alignment mark etched on the projector chassis is visible below the lamp assembly.
- 7 Tighten the 4 lamp-assembly screws.
- 8 Replace the service door and screw it into place.
- 9 Plug the power cord back into the projector and the wall outlet.

## ***Cleaning the air filter***

---

You should change or clean the air-intake filter after every 250 operating hours to maintain proper cooling. This filter is located on the bottom of the projector, under the grill.

- 1 Disconnect all cables and cords from the projector.
- 2 Set the projector on its side, connector panel down.
- 3 Loosen and remove both screws on the filter cover.

### ***Removing the screws on the air-filter cover***

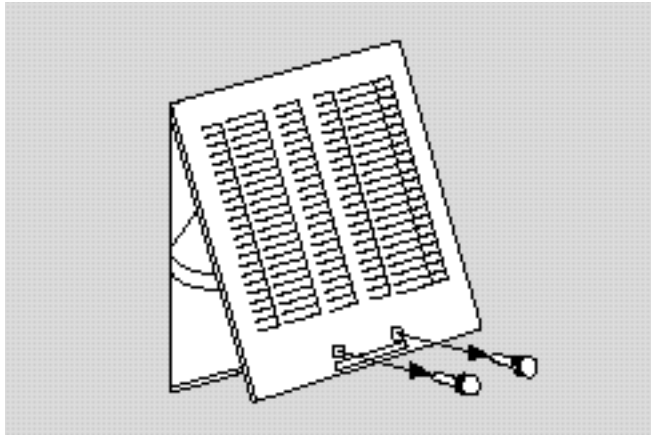

- 4 Press up on the air-filter cover tab to release the cover latch, and then pull the cover down and out.

***Removing the  
air-filter cover***

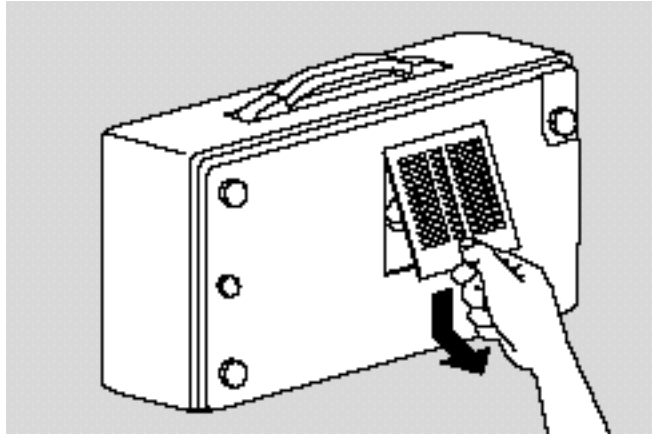

- 5 Remove the air filter and clean it with a vacuum cleaner. If dirt is hard to remove, wipe the air filter with a cloth moistened with water, then wipe it with a dry cloth.

***The components  
of the air filter***

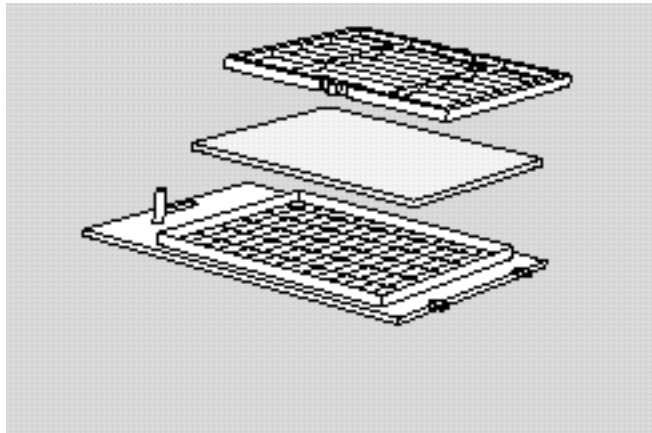

- 6 Reassemble and re-install the air filter.

## ***Changing the remote-control batteries***

---

If you are not planning to use the remote control for awhile, remove the batteries from the unit. To install or change the two AAA alkaline batteries in the remote control:

- 1 Locate the battery compartment at the lower rear of the case. Slide the cover back to open the compartment.
- 2 Insert new batteries, orienting them as illustrated inside the compartment.
- 3 Close the compartment by sliding the cover back into place.

Caution:

- Do not use batteries not specified for this unit.
- Do not use old and new batteries together.
- Do not insert batteries incorrectly.

# 5 Troubleshooting

## ***Troubleshooting guide***

---

<b><i>Symptom</i></b>	<b><i>Cause</i></b>	<b><i>Solution</i></b>
No image projected	No power to projector	Turn power ON Check AC cord Check power to electrical outlet
	Lamp not on	Turn lamp ON
	Lamp burned out	Replace lamp assembly
	Over-temperature indication	Allow projector to cool; turn projector OFF and then ON; make sure the bottom air-filter door is closed
No computer image projected	Loose cable	Check and secure cable connections
	No power to computer	Turn on computer
	Incompatible video system	If possible, check computer with another monitor

---

<b>Symptom</b>	<b>Cause</b>	<b>Solution</b>
No video image	Video source(s)	Check power on the video source(s)
	Loose cable	Check and secure cable connections between video source and projector
LAMP indicator glowing red	Burned-out lamp	Replace lamp assembly
Displayed image not square (keystoning)	Projector set at wrong angle to projection screen	Adjust relative positions of projector and screen
Projected image out of focus	Projection lens not focused	Adjust the lens focus
Projected image larger than screen	Zoom lens not adjusted properly, or projector too far from screen	Adjust zoom lens, or move projector closer to screen
Projected image smaller than the screen	Zoom lens not adjusted properly, or projector too close to screen	Adjust zoom lens, or move projector away from screen
Image off center	H. or V. POSIT adjusted incorrectly	Adjust H. and/or V. POSIT; if image does not center, check for compatibility problems
	Compatibility problem	Verify projector is image compatible with one of the standards listed in <i>Appendix A: Specifications</i>
	Misalignment or damage to optical elements	Projector requires service

<b>Symptom</b>	<b>Cause</b>	<b>Solution</b>
No image on computer screen	Power switch is off or projector is not running	Computer must be on for computer monitor to display
	Lamp is burned out	Turn off projector; replace lamp
	Cable not connected	Connect cable
Streaks on monitor	Video cable plugged into computer or projector is upside-down	Check computer- or projector-cable connections
Faint screen	Low intensity	Adjust BRIGHT (brightness) and CONTRAST settings
Jittery, fuzzy letters	Out of sync	Adjust H. PHASE setting
Cannot get entire image on screen; scrambled image	Compatibility problems	Verify projector is image compatible with one of the standards listed in <i>Appendix A, Specifications</i>
Shimmering colors	H. PHASE or BRIGHT setting out of adjustment	Adjust H. PHASE or BRIGHT (brightness) settings
Colors weak in video mode (NTSC/PAL/S-VHS)	Weak video signal	Check for faulty video source, bad connection, frayed cable
	COLOR setting may be too low	Adjust COLOR setting
Getting excessive white or washout in NTSC, PAL or S-VHS mode	CONTRAST setting too high	Adjust CONTRAST setting, then adjust BRIGHT (brightness) setting
No audio	Audio source(s)	Check audio source(s) for power ON and proper operation
	Loose/wrong cables	Check and secure cables between audio source(s) and projector



<b>Symptom</b>	<b>Cause</b>	<b>Solution</b>
TEMP indicator	Air vent(s) clogged	Allow projector to cool; clear obstructions from vents  Clean or replace filter as necessary
	Internal fan failure	Allow projector to cool; check for fan and blower operation; service if necessary
	Bottom air-filter door is open	Close bottom air-filter door
Remote control does not work	Batteries upside-down or old	Check battery placement or replace with new batteries
	Projector infrared receiver window blocked	Remove object obstructing infrared receiver on front of the projector
	Out of range	Move within 20 feet and within a 30° angle to the front of the projector
Remote control does not work as a mouse control	Serial cable not connected	Connect cable
	Wrong mouse driver installed	Use Microsoft serial mouse driver
	Projector turned on out of sequence	Turn on projector, connect cable, and turn on computer
The mouse cursor does not appear in Windows	Windows does not detect a mouse connected to the computer	Open the projector menus and choose OPT. Select COM Speed and make sure it is set to 1200 baud  Select COM Bits and make sure it is set to 7N1  <b>Restart Windows</b>

<b>Symptom</b>	<b>Cause</b>	<b>Solution</b>
The mouse cursor appears in Windows but does not respond to the remote control	The projector host-mode mouse function is disabled	Open the projector menus and choose OPT. Select COM Speed and make sure it is set to 1200 baud  Select COM Bits and make sure it is set to 7N1
The mouse cursor appears in Windows and responds to the integrated pointing device but not to the remote control	The notebook is not configured for or does not support dual mouse input.	Check the notebook user's guide for details about dual mouse input or how to disable the built-in mouse

---

### ***Where to get help***

If at any time you need help:

- 1 Check the *Troubleshooting guide*.
- 2 Call your dealer's technical support line and explain your problem.
- 3 Call Polaroid Corporation (see pages 56 and 57).

## ***Polaroid Offices and Service Centers***

---

Australia  
 Polaroid Australia Pty. Ltd.  
 13-15 Lyonpark Road  
 P.O. Box 163  
 North Ryde, N.S.W. 2113  
 Tel.: (02) 9 950 7000  
 Fax: (02) 887 2209

Belgique/België  
 Polaroid (Belgium) N.V.-S.A.  
 Rue Colonel Bourg 111  
 Kolonel Bourgstraat 111  
 1140 Bruxelles-1140 Brussel  
 Tel.: 32 2 702 86 20  
 Fax: 32 2 726 92 99  
 Toll free: 32 78 155 905

Brasil  
 Polaroid do Brasil Ltda.  
 Av. Paulista, 1776-11º andar  
 Cerqueira Cesar  
 São Paulo-Capital  
 01310-921  
 Tel.: 55.11.285.6411  
 Fax: 55.11.283.2625  
       288.6521  
       287.5393

Canada  
 Polaroid Canada Inc.  
 350 Carlingview Drive  
 Etobicoke, Ontario M9W 5G6  
 Toll free: 1-800-268-6970

Danmark  
 Polaroid a.s.  
 Blokken 75  
 3460 Birkerød  
 Tlf.: 42 81 75 00  
 Fax: 42 81 70 26

Deutschland  
 Polaroid GMBH  
 Sprendlinger Landstrasse 109  
 63069 Offenbach  
 Tel.: 069 8404 1  
 Fax: 069 8404 204

España  
 Polaroid (España), S.A  
 Calle Orense, 16  
 2ª planta  
 28020 Madrid  
 Tno: 34-1-597.02.52  
 Fax: 34-1-597.27.82

France  
 Polaroid (France) S.A.  
 B.P. 7  
 78996 Elancourt Cédex  
 Tel.: (1) 30 68 38 38  
 Fax: (1) 30 68 38 39

Hong Kong  
 Polaroid (Far East) Ltd.  
 32/F Windsor House  
 311 Gloucester Road  
 Causeway Bay  
 Tel.: (852) 2894 0333  
 Fax: (852) 2895 1382

Italia  
 Polaroid (Italia) S.p.A.  
 Via Piave 11  
 21051 Arcisate (Varese)  
 Tel.: 0332-470031  
 Fax: 0332-478249

Japan  
 Nippon Polaroid  
 Kabushiki Kaisha  
 Mori Building No. 30  
 Toranomon 3-2-2  
 Minato-ku  
 Tokyo 105  
 Tel.: 81-3-3438-8811  
 Fax: 81-3-3433-3537

México  
 Polaroid de México S.A. de C.V.  
 Paseo de la Reforma 195  
 Piso 17  
 C.P. 06500 México, D.F.  
 Tel.: 703-1111  
 Fax: 566-0505  
 Del interior al 91 (800) 70-727  
 Ventas 91 (800) 70-747

Nederland  
 Polaroid Nederland B.V.  
 Zonnebaan 45  
 3606 CH Maarssen  
 PO Box 1219  
 3600 BE Maarssen  
 Tel.: 31-30-2-410-420  
 Fax: 31-30-2-411-969

Reparaties:  
 Polaroid (Europe) B.V.  
 Hoge Bothofstraat 45  
 7511 ZA Enschede  
 Tel.: 31-53-4-865-400

New Zealand  
 Polaroid New Zealand Ltd.  
 Camera Services  
 24-26 Anzac Avenue  
 Auckland  
 Tel.: (09) 377 3773

Norge  
 Polaroid (Norge) A/S  
 Industriveien 8B, 1473 Skårer  
 Postboks 80, 1471 Skårer  
 Tlf: 67 90 47 10  
 Fax: 67 90 51 73

Österreich  
 Polaroid Ges.m.b.H.  
 Eitnergasse 5A  
 1231 Wien  
 Tel.: 869 86 27  
 Fax: 869 81 00

Portugal  
 Polaroid (España) S.A.  
 Sucursal em Portugal  
 Edificio Monumental  
 Avenida Praia da Vitória, 71-A 4º B  
 1050 Lisboa  
 Tel.: (01) 316.10. 52

Puerto Rico  
 Polaroid Caribbean Corporation  
 Centro de Seguros  
 Ave. Ponce de León 701  
 Miramar, Santurce 00907  
 Tel.: (809) 725-6240  
 Fax: (809) 725-5462

Schweiz/Suisse/Svizzera  
 Polaroid AG  
 Hardturmstrasse 133  
 8037 Zürich  
 Tel.: (01) 277.72.72

Suomi  
 Polaroid Oy  
 Sinikalliontie 10  
 02630 Espoo  
 Puh: 90-502 35 33  
 Fax: 90-502 35 50

Sverige  
 Polaroid AB  
 Ekholmsvägen 34  
 Box 204  
 127 24 Skärholmen  
 Tel.: 08-710 08 50  
 Fax: 08-740 73 68

U.K.  
 Polaroid (U.K.) Ltd. &  
 Polaroid Export Operations  
 Wheathampstead House  
 Codicote Road  
 Wheathampstead  
 Hertfordshire AL4 8SF  
 U.K.  
 Tel: (44) 1582 632000  
 Freefone: 0800 010119

U.S.A.  
 Polaroid Corporation  
 Technical Assistance  
 Tel.: Toll free 1-800-432-5355  
 Call for the nearest Polaroid  
 location

## ***One Year Warranty***

---

Polaroid Corporation warrants your Polaview Projector equipment against defects in manufacture for a period of one year from the date of purchase. To verify the warranty period, you should keep the sales slip or other proof of the purchase date.

Should this product, or any component or accessory included with it, become defective at any time during the warranty period, Polaroid Corporation will, at its discretion, either replace or repair this item, without charge, provided the product is returned to a designated servicing location (prepaid and insured). To ship the unit, pack the carrying case in the original carton or equivalent, with plenty of padding.

This Warranty does not apply to product damage resulting from accident, incorrect installation, unauthorized modification, misuse or abuse.

**THIS WARRANTY EXCLUDES ALL INCIDENTAL AND CONSEQUENTIAL DAMAGES AND DOES NOT AFFECT YOUR STATUTORY RIGHTS.**

Note: No user-serviceable parts inside. Attempts to modify mechanical or electronic parts inside will void your warranty, and may be hazardous.

# Appendix A: Specifications

<b><i>Number of colors</i></b>	16.7 million colors
<b><i>Display</i></b>	3 polysilicon liquid crystal panels
<b><i>Computer compatibility</i></b>	PC (VGA) Apple Macintosh and Powerbook series Quadra, Centris, Video NTSC/PAL/ SECAM/S-Video
<b><i>Video compatibility</i></b>	NTSC, PAL, SECAM and S-VHS
<b><i>Projection lamp</i></b>	250 watt metal-halide lamp
<b><i>Optics</i></b>	Zoom lens F3.0 - 3.8, f46.5 - 74.4mm
<b><i>Keystone correction</i></b>	8.8°
<b><i>Audio system</i></b>	One built-in speaker, 3 watt

---

<b>Input</b>	2 computer video 2 TV video (NTSC, PAL, SECAM, S-VHS) 2 computer stereo audio 2 TV stereo audio RS-232 control port Cyclops interactive pointer system
<b>Outputs</b>	Stereo audio 1 RGB monitor
<b>Power source</b>	100-120 VAC, 5A or 220-240 VAC, 2A
<b>Dimensions</b>	12.6 in. W x 18.2 in. L x 6.9 in. H
<b>Weight</b>	23.1 lbs.

---

# Appendix B: Parts

<b><i>Replacement product</i></b>	<b><i>Part no.</i></b>
Lamp assembly	L84
Remote control	A15
Power cord: U.S.	C151-10
Power cord: Europe	C152-10
VGA video cable	C950-06
VGA - Macintosh cable adapter	C951
AV cable	C550-6
Serial cable	C551-6
Mini-stereo to mini-stereo cable	900-55010
Lens cap	280-00099
Air filter	280-00186

<b><i>Optional accessory</i></b>	<b><i>Model/Part no.</i></b>
Rolling hard case	A295
Rolling soft case	A298
Cyclops interactive pointer system	A2075
S-Video cable	C552-6

You can order accessories and replacement parts through your local dealer or by contacting Polaroid (see pages 56 and 57).



# Index

## A

---

Accessories, 61  
AC power switch, 9, 14, 15  
Air filter, 48  
AUDIO, 6, 14  
Audio connection  
  Computer, 20  
  Non-computer, 22  
AUDIO IN 1 & 2, 6, 13  
AUDIO OUT, 7, 14, 23  
AUDIO OUT ports  
  External speaker  
    system connection, 23  
  External stereo  
    system connection, 23  
AUDIO ports  
  Monaural source, 22  
  Stereo source, 22  
AUTO OFF, 43

## B

---

BLANK, 40  
BRIGHT, 37

## C

---

COLOR, 37  
COM. BITS, 42  
COM. SPEED, 42  
Composite video  
  connections, 21  
Computer audio  
  connections, 20  
Computer audio port, 20  
Computer video connection  
  Macintosh computers, 17  
  Notebook computers, 19  
  PC, 16  
  Special configurations, 20  
Connector panel, 6, 13  
Contents of box, 2  
CONTRAST, 37  
Control-panel indicators, 29  
Control-panel keys, 7, 28  
CONTROL port, 7, 14, 22  
CYCLOPS, 41  
Cyclops connection, 23  
Cyclops interactive pointer  
  system, 6, 8  
CYCLOPS port, 6, 13

---

**F**

---

FOCUS +/-, 44  
FOCUS +/- key, 7  
Focusing the image  
    Non-zoom models, 26  
    Zoom lens models, 26

---

**G**

---

Getting started, 10  
Graphical user interface, 35

---

**H**

---

Host mode  
    Desktop computers, 34  
    Notebook computers, 34  
H. PHASE, 38  
H. POSIT, 38  
H. SIZE, 38

---

**I**

---

IMAGE menu, 40  
IMAGE menu items  
    BLANK, 40  
    CYCLOPS, 41  
    MENU SIZE, 41  
    MESSAGE, 41  
    MIRROR, 40  
    REVEAL, 41  
Image size, 27  
Infrared eye, 31  
INPUT key, 7, 28  
INPUT menu, 39  
INPUT menu items  
    RGB 1 or 2, 39  
    TEST PATTERN, 39  
    VIDEO 1 or 2, 39

---

**J**

---

Joystick, 33

---

**L**

---

LAMP indicator, 8, 29, 30  
Lamp replacement, 46  
LANGUAGE, 43  
Laptop connections, 19  
Lens cleaning, 45  
Local mode, 33

---

**M**

---

Macintosh adapters, 17  
Macintosh connections, 17-18  
Main menu, 36  
Maintenance  
    Air filter cleaning, 48  
    Lamp replacement, 46  
    Lens cleaning, 45  
    Remote-control batteries, 50  
MENU key, 8, 28, 29  
MENU SIZE, 41  
MESSAGE, 41  
MIRROR, 40  
MOUSE, 43  
MUTE key, 7, 28

---

**N**

---

Notebook connections, 19  
Notebooks, 4

---

**O**

---

- ON indicator, 8, 29
- Operating modes
  - Host mode, 34
  - Local mode, 33
- OPT. menu items
  - AUTO OFF, 43
  - COM. BITS, 42
  - COM. SPEED, 42
  - LANGUAGE, 43
  - MOUSE, 43
  - TIMER, 43
- OPTION (OPT.) menu, 42
- Ordering parts, 61
- Over-temperature, 30

---

**P**

---

- Parts, 61
- PC connections, 16, 22
- Polaview Model 110
  - Turning off, 27
  - Turning on, 25
- Projector
  - Moving, 11
  - Positioning, 10
  - Transporting, 11
- Projector cooling and airflow, 12
- Projector operation
  - Using a mouse, 32
  - Using control panel and remote control, 34
- Power, 29
- Power receptacle, 6, 13, 15
- Power switch, 7, 14
- Power to the projector, 15

---

**Q**

---

- Quick menu adjustment items
  - FOCUS +/-, 44
  - SEARCH, VIDEO 1/2, RGB 1/2, 44
  - VOLUME +/-, 44
- Quick menus, 44
- Quick start
  - Desktop Macintosh computers, 3
  - Desktop PCs, 3
  - Notebooks, 4

---

**R**

---

- Remote-control batteries, 50
- Remote-control keys, 31-33
- Repair of your projector, 54
- Replacement parts, 61
- RESET key, 8, 28
- Returning your projector for repair, 54
- REVEAL, 41
- RGB IN 1 & 2, 6, 13
- RGB OUT, 7, 14
- RGB 1 or 2, 39

---

**S**

---

SEARCH, VIDEO 1/2,  
  RGB 1/2, 44  
SETUP menu, 37  
SETUP menu options  
  BRIGHT, 37  
  COLOR, 37  
  CONTRAST, 37  
  H. PHASE, 38  
  H. POSIT, 38  
  H. SIZE, 38  
  SHARPNESS, 37  
  TINT, 37  
  VOLUME, 37  
  V. POSIT, 38  
SHARPNESS, 37  
Special configurations, 5, 20  
Specifications, 59  
STANDBY/ON key, 7, 26, 28, 30  
S-Video 1 & 2, 6, 13  
S-Video source connections, 21

---

**T**

---

TEMP indicator, 8, 29, 30  
TEST PATTERN, 39  
TIMER, 43  
Timer, 44  
TINT, 37  
Troubleshooting guide, 51  
Turning off the projector, 27  
Turning on the projector, 25

---

**V**

---

VGA connections, 16  
VGA video cable, 16  
VIDEO 1 & 2, 6, 13  
VIDEO 1 or 2, 39  
Video input ports  
  Composite video  
    connections, 21  
    S-Video connections, 21  
VOLUME, 37  
VOLUME +/-, 44  
V. POSIT, 38

---

**Z**

---

ZOOM +/- key, 7, 26, 28, 31



"Polaroid" and "Polaview" are trademarks of Polaroid Corporation, Cambridge, MA, U.S.A. "Proxima" and "Cyclops" are registered trademarks of Proxima Corporation. "IBM" is a trademark of International Business Machines Corporation. "Macintosh" is a trademark of Apple Computer, Inc. Other trademarks may be the property of their respective owners.